

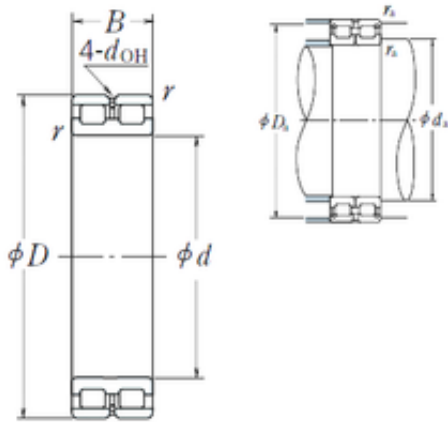

AMERICAN NTN BEARING MFG.CORP.



110 mm x 150 mm x 40 mm NSK RSF-4922E4 FULL-COMPLEMENT CYLINDRICAL ROLLER BEARINGS

Bearing No. RSF-4922E4

RSF-4922E4 Bearing 2D drawings and 3D CAD models

Size	110x150x40 mm
Bore Diameter	110 mm
Outer Diameter	150 mm
Width	40 mm
d	110 mm
D	150 mm
B	40 mm
C	40 mm
r min.	1,1 mm
da min.	116,5 mm
Da max.	143,5 mm
ra max.	1 mm
Weight	2,15 Kg
Basic dynamic load rating (C)	202 kN
Basic static load rating (C0)	430 kN
(Grease) Lubrication Speed	900 r/min
hidYobi	RSF-4922E4
LangID	1
D_	150
B_	40
hidTable	ecat_NSCLDRS
Oil rpm	900
mass	2.15
GRS rpm	1800



AMERICAN NTN BEARING MFG.CORP.

ra	1
da_min	116.5
C0	430
DE_	138.4
Prod_Type3	CRB_FRFS_OT_FREE
DA_	9
Z_	45
yobi	RSF-4922E4
da_max	143.5
SDM_	129.4
r	1.1
KBRG	4210
disp	2
DI_	120.4
doh	3