

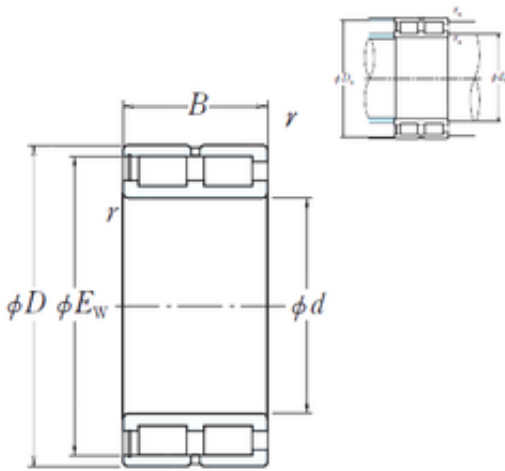

AMERICAN NTN BEARING MFG.CORP.

110 mm x 170 mm x 80 mm NSK NNCF5022V FULL-COMPLEMENT CYLINDRICAL ROLLER BEARINGS

Bearing No. NNCF5022V



NNCF5022V Bearing 2D drawings and 3D CAD models

Size	110x156.3x80 mm
Bore Diameter	110 mm
Outer Diameter	156,3 mm
Width	80 mm
d	110 mm
D	170 mm
Ew	156,3 mm
B	80 mm
C	80 mm
r min.	2 mm
Da	157 mm
ra max.	2 mm
da	122 mm
Weight	6,1 Kg
Basic dynamic load rating (C)	490 kN